

Idrobox



La lavanderia che arreda 125 elementi. Finiture: Idropan melaminico bianco, Idropan laccato opaco 35 colori. 3 versioni maniglia. Piede o zoccolo H. 12 cm. Piani: Idropan rivestito laminato - Korakril bianco.

Idrobox the collection to furnish your laundry room. Finishes: Idropan white melamine, Idropan lacquer in 35 mat colours. 3 handle versions. Foot or plinth H. 12 cm. Idropan covered by laminate - Korakril white.

Idrobox die Wäscherei die einrichtet 125 Elementen. Ausführung: Idropan Melaminbeschichtet Weiß, Idropan matt lackiert 35 Farbe. 3 Griff Typen. Füß und Sockel H. 12 cm. Platte: Idropan laminatbeschichtet - Korakril Weiß.

Idrobox la blanchisserie qui meuble 125 éléments. Finissions: Idropan en mélaminé blanc, Idropan laqué en 35 couleurs. 3 versions de poignée. Pied et plinthe H. 12 cm. Idropan laminé - Korakril blanc.

Idrobox el cuarto de lavandería que decora 125 elementos. Acabado: Idropan melamina blanca, Idropan lacado mate 35 colores. 3 versiones de tiradores. Pie o zócalo A. 12 cm. Encimeras: Idropan revestido de laminado - Korakril blanco.

Frontali - Struttura: Melaminico

*Fronts - Structure: Melamine
Fronten - Struktur: Melaminb. Holz
Façades - Structure: Mélaminé
Frentes - Estructura: Melamina*

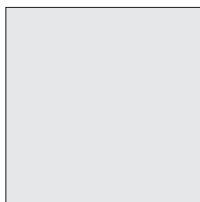

050

bianco - white - weiß
blanc - blanco

Frontali - Struttura: Laccato opaco

*Fronts - Structure: Mat lacquered
Fronten - Struktur: Matt lackiert
Façades - Structure: Laqué mat
Frentes - Estructura: Lacado mate*

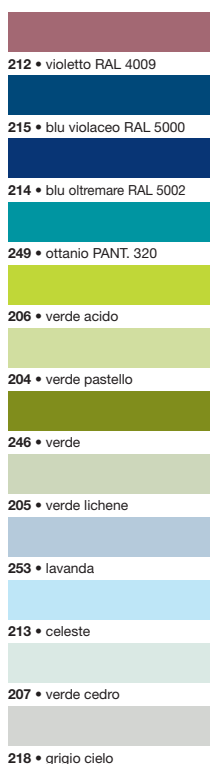
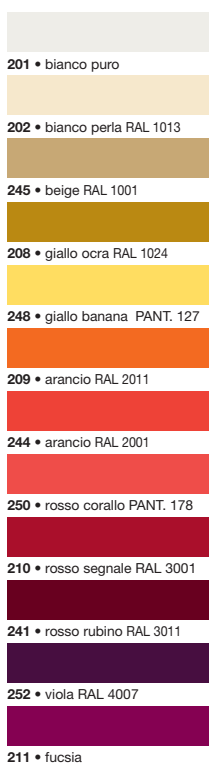

Maggiorazione prezzo + 20%
Price increase + 20%
Aufpreis + 20%
Augmentation sur le prix + 20%
Recargo + 20%

Scelta tipo maniglia

*Handle' chiose
Grifftyp
Choix de pignée
Tipo de tirador*

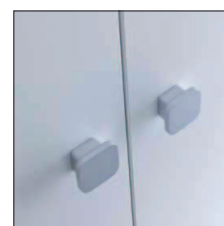

Tipo
Type • Typ
Type • Tipo
1

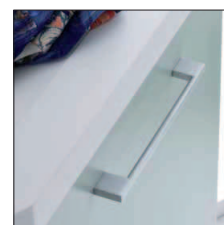

Tipo
Type • Typ
Type • Tipo
2



Tipo
Type • Typ
Type • Tipo
3

COMBINAZIONI FINITURE

Miscellaneous of finishing
Kombination der Feinbearbeitung
Combinaison des finitions
Combinación de colores

Idrobox

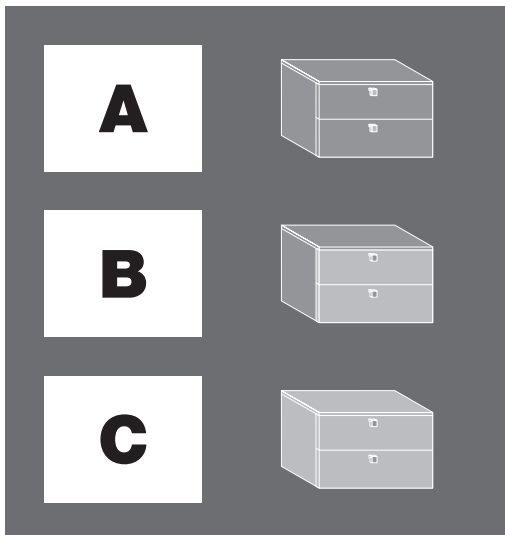

Struttura: Melaminico

Structure: Melamine
Struktur: Melaminb. Holz
Structure: Mé laminé
Estructura: Melamina

Frontali: Melaminico

Fronts: Melamine
Fronten: Melaminb. Holz
Façades: Mé laminé
Frentes: Melamina

Struttura: Melaminico

Structure: Melamine
Struktur: Melaminb. Holz
Structure: Mé laminé
c: Melamina

Frontali: Laccato opaco

Fronts: Matte laquer
Fronten: Matt lackiert
Façades: Laqué mat
Frentes: Lacado mate

Struttura: Laccato opaco

Structure: Matte laquer
Struktur: Matt lackiert
Structure: Laqué mat
Structure: Lacado mate

Frontali: Laccato opaco

Fronts: Matte laquer
Fronten: Matt lackiert
Façades: Laqué mat
Frentes: Lacado mate

CARATTERISTICHE TECNICHE

Technical characteristics
Technische Charakteristichen
Données techniques
Características técnicas

Idrobox



PIEDINO H. 12 IN TECNOPOLIMERO VERNICIATO ALLUMINIO REGOLATORE POSTERIORE BREVETTATO

FOOT H. 12 CM IN TECHNO POLYMER ALUMINIUM VARNISHED PATENTED
BACK REGULATION
FUSS H. 12 CM AUS TECHNO- POLYMER ALUMINIUM LACKIERT HINTERE
REGULATION PATENTIERT
PIED H. 12 CM IN TECHNO POLYMÈRE LAQUÉ ALUMINIUM RÉGULATION
POSTÉRIEURE BREVETÉE
PATA A. 12 CM EN TECNO - POLÍMERO BARNIZADO ALUMINIO REGULADOR
POSTERIOR PATENTADO

POMOLO fin. ALLUMINIO

KNOB ALUMINIUM FINISH • KNOFF ALUMINIUM AUSFÜHRUNG
BOUTON FINITION ALUMINIUM • POMO ACABADO ALUMINIO

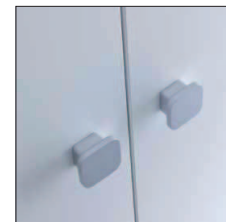

Tipo
Type • Typ
Type • Tipo
1



ZOCCOLO H. 12 IN ESTRUSO PLASTICO RIVESTITO FOGLIA ALLUMINIO

PLINTH H. 12 CM IN EXTRUDED PLASTIC COVERED BY ALUMINIUM LEAF
SOCKEL H. 12 CM AUS GEPRESSTE PLASTIK, ALUMIUMFOLIE BESCHICHTET
PLINTHE H. 12 CM EN PLASTIQUE EXTRUDÉE COUVERT AVEC FOUILLE ALUMINIUM
ZÓCALO A. 12 CM EXTRUDIDO PLÁSTICO REVESTIDO DE PAN DE ALUMINIO

MANIGLIA A PONTE fin. ALLUMINIO

HANDLE ALUMINIUM FINISH • GRIFF ALUMINIUM AUSFÜHRUNG
POIGNÉE FINITION ALUMINIUM • TIRADOR ACABADO ALUMINIO

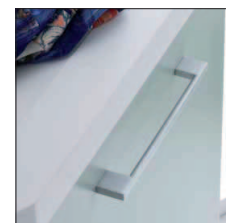

Tipo
Type • Typ
Type • Tipo
2



CASSETTI CON SPONDA IN MELAMINICO BIANCO CON GUIDA AD ESTRAZIONE TOTALE REGOLABILE

DEEP DRAWER WITH SIDE IN WHITE MELAMINE WITH TOTAL EXTRACTION AND
ADJUSTABLE SLIDE
SCHUBLADEN MIT WEISSE SEITEN UND REGULIERBARE AUSZIEHBARE SCHIENE
TIROIRS AVEC CÔTÉS EN MÉLEMINÉ BLANC AVEC COULISSE AVEC
EXTRACTION TOTALE RÉGLABLE
CAJONES CON LATERALES DE MELAMINA BLANCA CON GUÍAS A EXTRACCIÓN
TOTAL REGULABLES

MANIGLIA AD UNGHIA fin. ALLUMINIO

NAIL HANDLE ALUMINIUM FINISH • GRIFF NAGEL ALUMINIUM
AUSFÜHRUNG • POIGNÉE FINITION ALUMINIUM • ACABADO ALUMINIO



Tipo
Type • Typ
Type • Tipo
3

MODULARITÀ

Modularity
Möglichkeiten
Modularité
Módulos

Idrobox

BASI E COLONNE • Base units and towels • Basen und Säulen • Bases e colonne • Base y columna

ALTEZZA
Heights • Höhenmasse • Hauteur • Las alturas

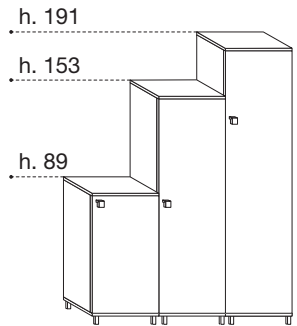

PROFONDITÀ
Depths • Tiefenmasse • Profondeur • Profundidad

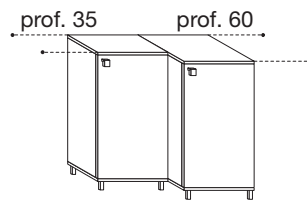

LARGHEZZA
Widths • Breitenmasse • Les largeurs • Las anchuras

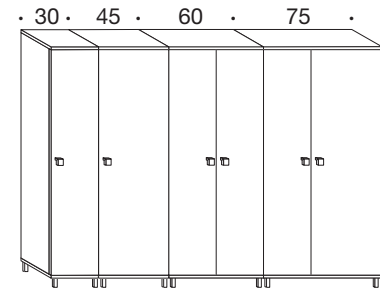

PENSILI • Wall units • Häng-Schränke • Meubles suspendu • Muebles suspendidos

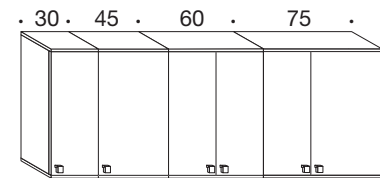
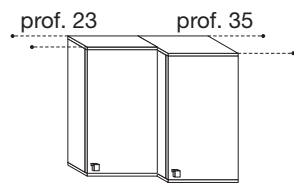
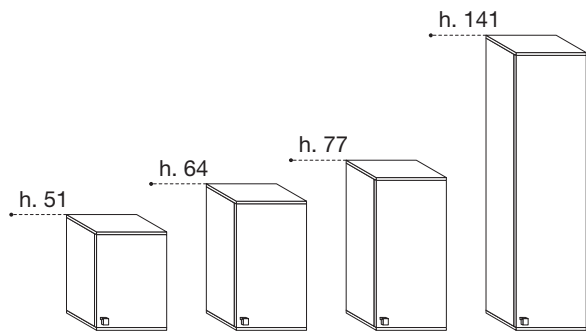

SOPRALZI • Overlapped units • Übereinander-Legender Schrank • Meubles superposés • Altillos

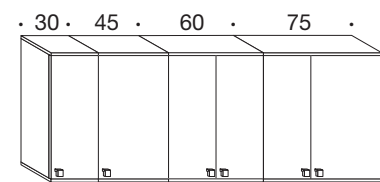
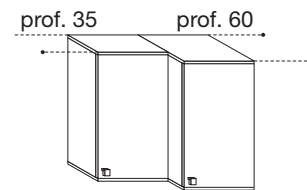
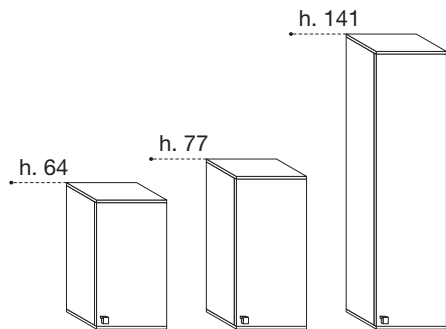

Esempio di colonne sovrapposte

Example of stacked tall units
Beispiel mit übereinander stehenden Schränken
Exemple de colonnes superposées
Ejemplo de muebles sobrepuestos

